

LET'S PARTY | 16 cards, 4 each of 4 designs

Featured Technique: Coloring with Markers



Materials Needed:

- G1296 Let's Party Cardmaking Workshop Kit
- Z6508 Bluebird Exclusive Inks™ Stamp Pad
- Z6509 Candy Apple Exclusive Inks™ Stamp Pad
- Z6521 Sundance Exclusive Inks™ Stamp Pad
- Z4189 Intense Black Exclusive Inks™ Stamp Pad
- Z2518 Coral Shades TriBlend™ Marker
- Z4575 Black LePen™
- Z2060 Thin 3-D Foam Tape
- Z5038 Die-cutting & Embossing Machine

- Y1000 1" x 1" My Acrylix® Block
- Y1003 2" x 2" My Acrylix® Block
- Y1009 2" x 3½" My Acrylix® Block
- Paper Trimmer
- Scissors
- Adhesive
- Ruler
- Sticky Notes

Exclusive Stamp + Thin Cuts:



Getting Started:

- Gather all materials needed.
- Trim all zip strips and set aside. The zip strip is the 1/2" accent paper along the top of each sheet of patterned paper.
- Check the cut orientation below each cutting guide image. This will show you how to cut the paper, keeping the patterns on your project pieces facing the right direction.
- Light grey pieces on your cutting guide are project pieces. White pieces, not including labeled project pieces that must be die cut, are leftover paper.
- As you cut the paper, label and sort the pieces as indicated in the cutting guide, creating a stack for each project.
- In order to die-cut two shapes at once, place the die on top of two stacked paper pieces before running the paper through your die-cutting machine. Paper pieces that can be stacked for die-cutting will be labeled, "stack."

Key:

✂ = first cut | * = use back of paper | P = Project

■ = suggested Thin Cuts arrangement

■ = suggested stamp arrangement

(See project instructions for ink color and other details)

Cutting Diagrams:

zip strips

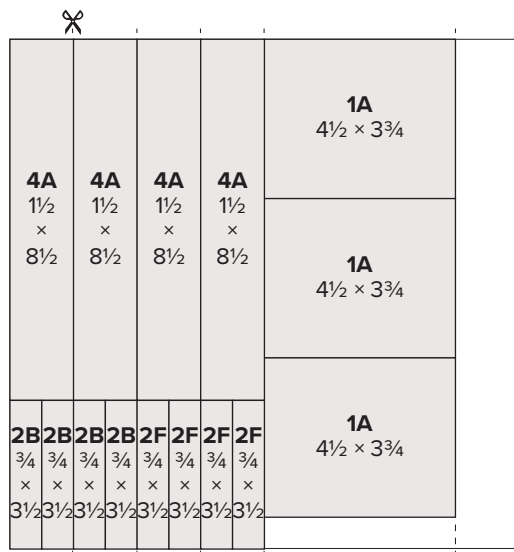
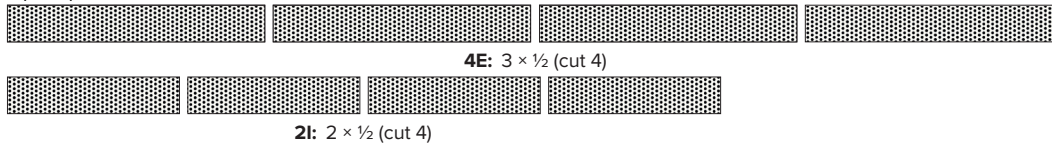

cut orientation



front

*back

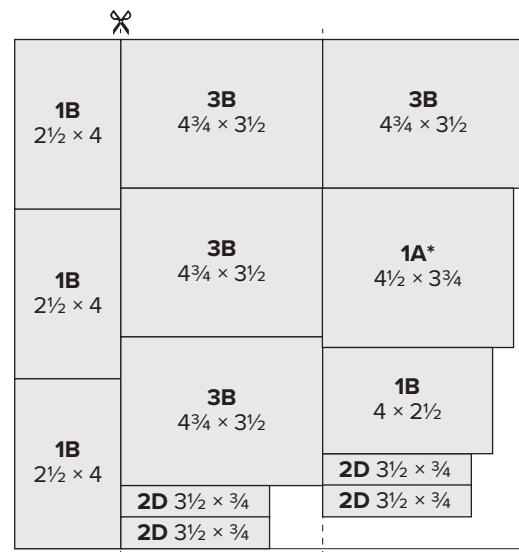

cut orientation



front

*back

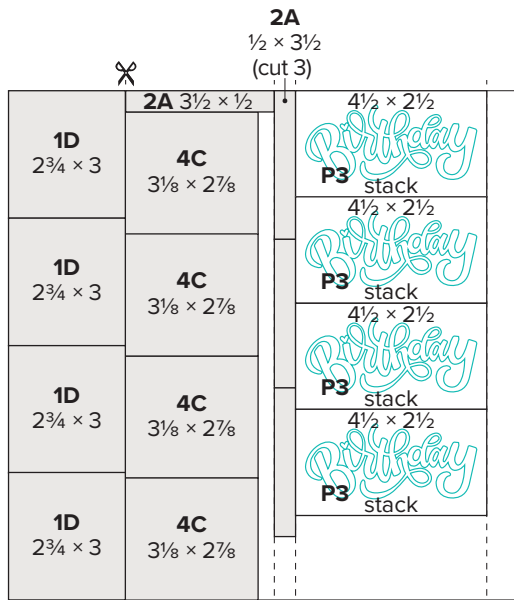

Candy Apple cardstock



dark

*light

Tip: See the Getting Started section on page two for additional information on how to make two die-cuts at once.

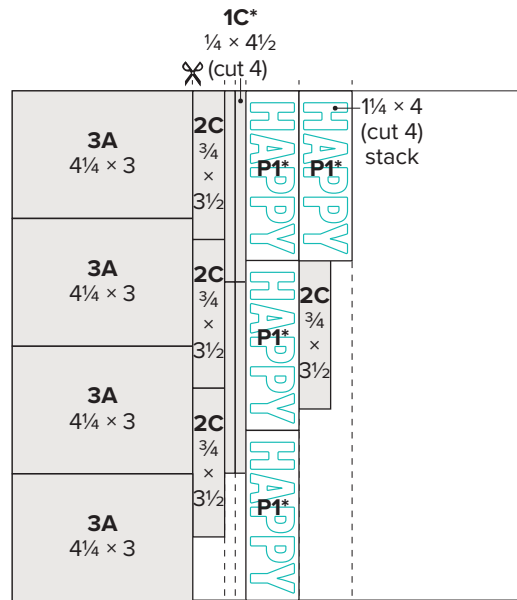

Bluebird cardstock



light

*dark

Tip: See the Getting Started section on page two for additional information on how to make two die-cuts at once.

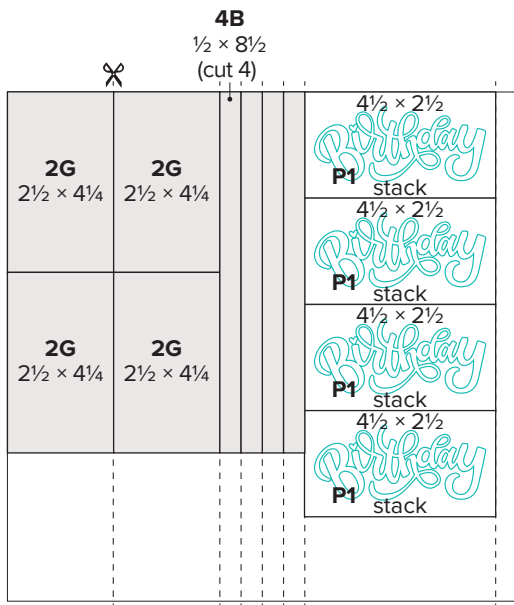

Periwinkle cardstock



dark

*light

Tip: See the Getting Started section on page two for additional information on how to make two die-cuts at once.

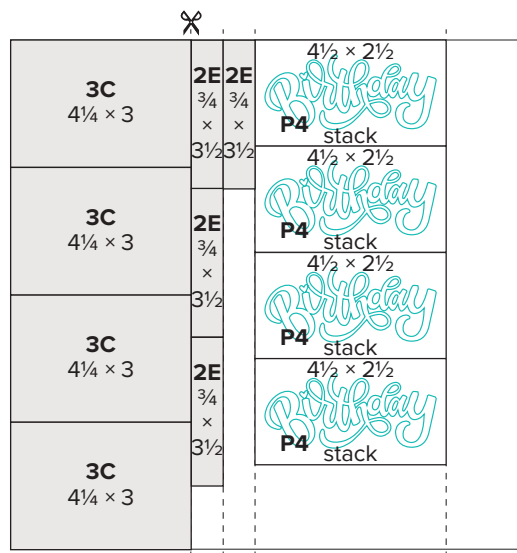

Sundance cardstock



light

*dark

Tip: See the Getting Started section on page two for additional information on how to make two die-cuts at once.



3D 2 ³ / ₄ × 4	4D 2 ³ / ₄ × 3	3D 2 ³ / ₄ × 4	2H 3 ³ / ₄ × 2
			2H 3 ³ / ₄ × 2
3D 2 ³ / ₄ × 4	4D 2 ³ / ₄ × 3	1E 2 ³ / ₄ × 2 ¹ / ₂	2H 3 ³ / ₄ × 2
	4D 2 ³ / ₄ × 3	1E 2 ³ / ₄ × 2 ¹ / ₂	2H 3 ³ / ₄ × 2
3D 2 ³ / ₄ × 4	4D 2 ³ / ₄ × 3	1E 2 ³ / ₄ × 2 ¹ / ₂	1E 2 ³ / ₄ × 2 ¹ / ₂
			WISHES WISHES WISHES WISHES

White Daisy cardstock



Project 1: Make 4



Prepare (4):



fig. 1



fig. 2

Card Base:

Paper: card base, 1A, 1B

Ink: Bluebird

Tips: Attach 1A, as shown (fig. 1), then trim excess. Attach 1B, as shown (fig. 2), then trim excess. Stamp the sentiment last.



fig. 2

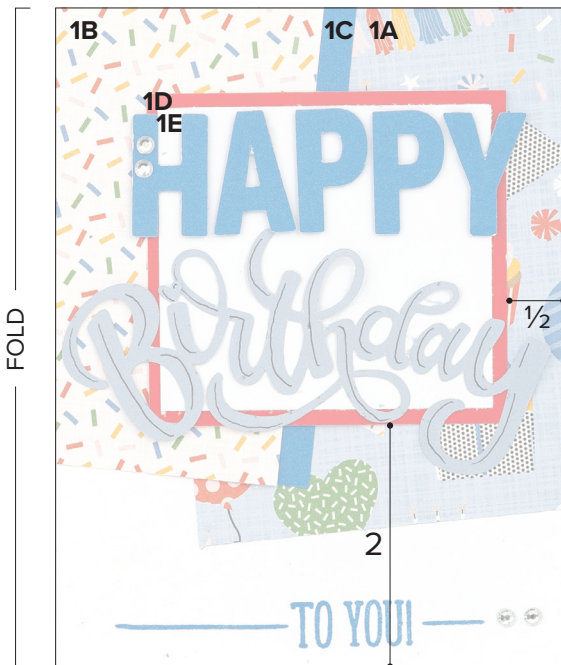

Assemble:

1. Prepare piece shown above
2. Attach 1C, as shown
Tip: Trim the excess hanging off the card base.
3. Attach 1D and 1E
4. Attach P1 Bluebird cardstock "HAPPY" sentiment with thin 3-D foam tape
5. Embellish P1 Periwinkle cardstock "Birthday" sentiment with Black LePen™, then attach
6. Embellish with sparkles

Project 2: Make 4

Prepare (4):



2H:

Paper: White Daisy

Inks: Bluebird, Sundance, Intense Black

Tips: Stamp the arrows and "DAY!" using the selective inking and masking techniques. Once the ink is dry, color the sentiment with the lightest Coral Shades blend marker. Ink the edges of the cardstock with Bluebird ink by sliding them on the ink pad, until the desired amount of color is achieved.

Technique: Cover the arrows on the stamp with sticky notes, then ink the stamp with Intense Black. Remove the sticky notes, then stamp on 2H. Clean the stamp. Carefully apply Bluebird ink to the arrows on both ends of the stamp, not inking the "DAY!" portion, and stamp on 2H.

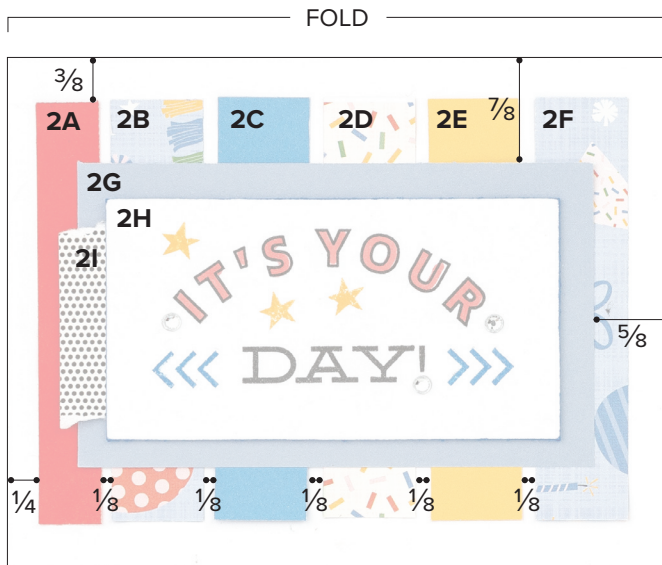

Assemble:

1. Prepare piece shown above
2. Attach 2A, 2B, 2C, 2D, 2E, and 2F
3. Attach 2G
4. Attach prepared 2H with thin 3-D foam tape
5. Tear approx. 1/4" from each short end of 2I and attach with thin 3-D foam tape, as shown
6. Embellish with sparkles

Project 3: Make 4

Prepare (4 each):



3D:
 Paper: White Daisy
 Inks: Bluebird, Candy Apple,
 Sundance, Intense Black



P3 Accent:
 Paper: White Daisy
 Ink: Bluebird
 Tip: Hand trim.



Assemble:

1. Prepare pieces shown above
2. Attach 3A
3. Attach 3B and 3C
4. Attach prepared 3D
5. Attach P3 Candy Apple cardstock "Birthday" sentiment
6. Attach prepared "Wishes" accent with thin 3-D foam tape, as shown
7. Embellish with sparkles

Project 4: Make 4

Prepare (4 each):



4D:
 Paper: White Daisy
 Ink: Intense Black
 Tip: Once the ink is dry, color the sentiment with the lightest and middle Coral Shades blend markers.



P4 Accent:
 Paper: Sundance
 Tip: Color the heart with the middle Coral Shades blend marker.

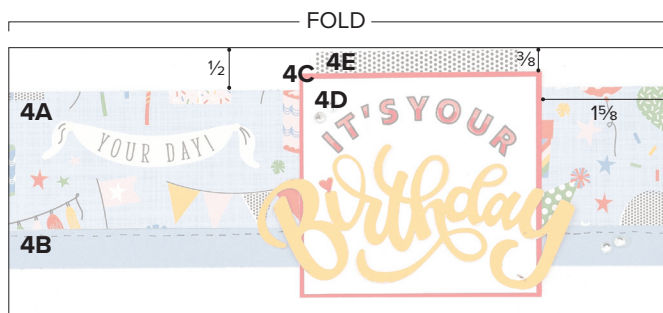

Assemble:

1. Prepare pieces shown above
2. Attach 4A and 4B
3. Draw dashed line on 4B with Black LePen™
4. Attach 4C and prepared 4D
Tip: Do not use adhesive along the top of 4C so another piece can be tucked behind it in a later step.
5. Attach prepared "Birthday" sentiment
6. Tear approx. 1/4" from both short ends of 4E, then attach, as shown
Tip: Tuck slightly behind 4C.
7. Embellish with sparkles