

COSETTE | 16 cards, 4 each of 4 designs

Featured Technique: Sponging



Materials Needed:

- G1276 Cosette Cardmaking Workshop Kit
- Z6536 Honey Butter Exclusive Inks™ Stamp Pad
- Z6539 Mist Exclusive Inks™ Stamp Pad
- Z2828 Toffee Exclusive Inks™ Stamp Pad
- Z3271 Archival Black Exclusive Inks™ Stamp Pad or
- Z2805 Black Exclusive Inks™ Stamp Pad or
- Z4189 Intense Black Exclusive Inks™ Stamp Pad
- Z697 Round Sponge
- Z5038 Die-cutting & Embossing Machine

- Y1000 1" x 1" My Acrylix® Block
- Y1016 1" x 1½" My Acrylix® Block
- Y1002 1" x 3½" My Acrylix® Block
- Y1003 2" x 2" My Acrylix® Block
- Paper Trimmer
- Scissors
- Adhesive
- Ruler
- Washi Tape

Exclusive Stamp + Thin Cuts:



Getting Started:

- Gather all materials needed.
- Trim all zip strips and set aside. The zip strip is the 1/2" accent paper along the top of each sheet of patterned paper.
- Check the cut orientation below each cutting guide image. This will show you how to cut the paper, keeping the patterns on your project pieces facing the right direction.
- Light grey pieces on your cutting guide are project pieces. White pieces, not including labeled project pieces that must be die cut, are leftover paper.
- As you cut the paper, label and sort the pieces as indicated in the cutting guide, creating a stack for each project.
- If there is a fold line present in a cutting diagram, cut the paper first before folding it. In order to die-cut two shapes at once, place the die on top of the folded paper or stack two paper pieces before running the paper through your die-cutting machine. Paper pieces that can be stacked for die-cutting will be labeled, "stack."

Key:

✂ = first cut | * = use back of paper | P = Project

- - - - = cut line

•••••• = fold line

■ = suggested Thin Cuts arrangement

Cutting Diagrams:

zip strips

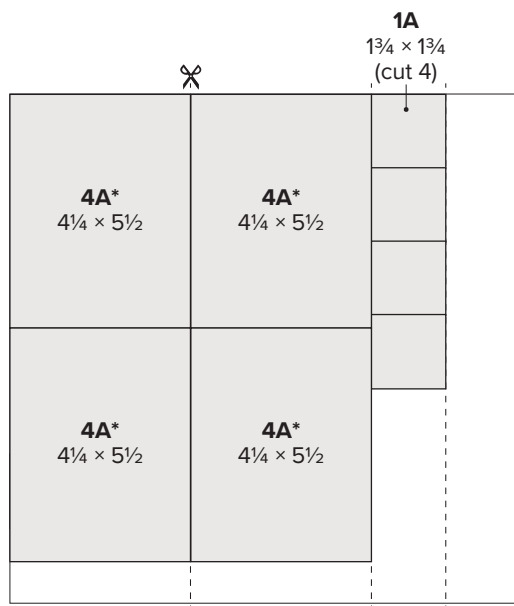
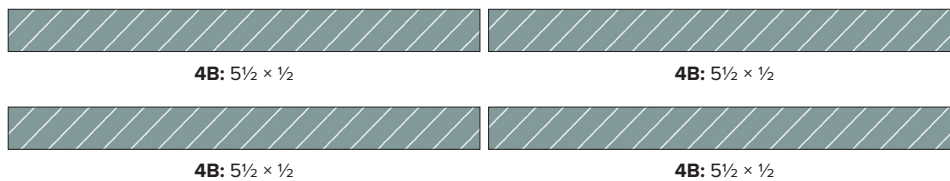

cut orientation

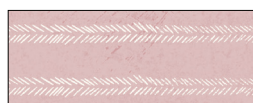

front



*back

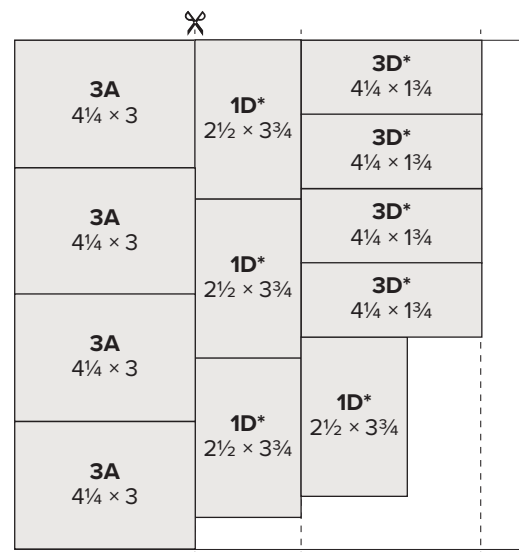

cut orientation



front



*back

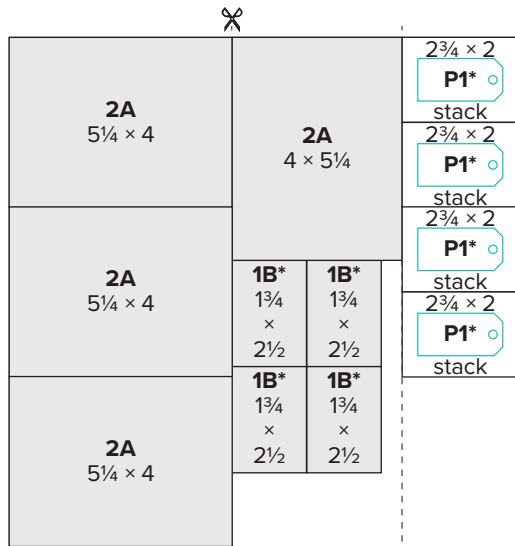

Toffee cardstock



dark

*light

Tip: See the Getting Started section on page two for additional information on how to make two die-cuts at once.

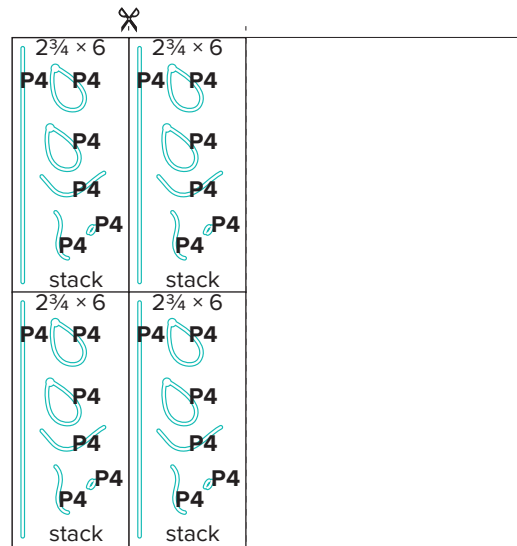

Toffee cardstock



dark

*light

Tip: See the Getting Started section on page two for additional information on how to make two die-cuts at once.

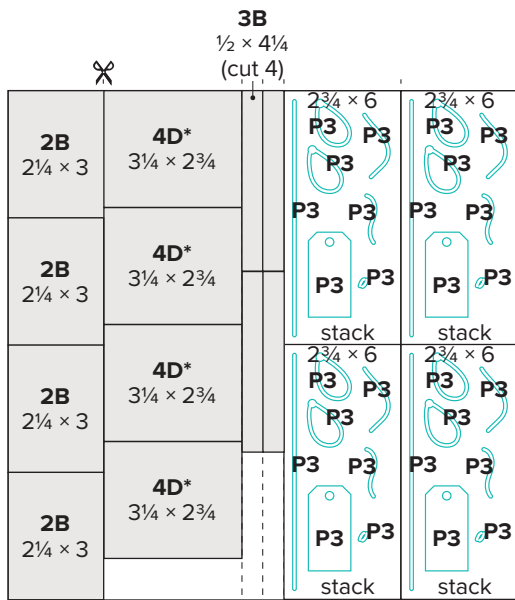

Mist cardstock

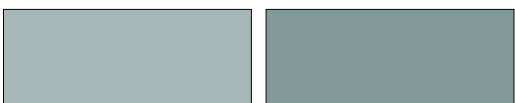

light

*dark

Tip: See the Getting Started section on page two for additional information on how to make two die-cuts at once.

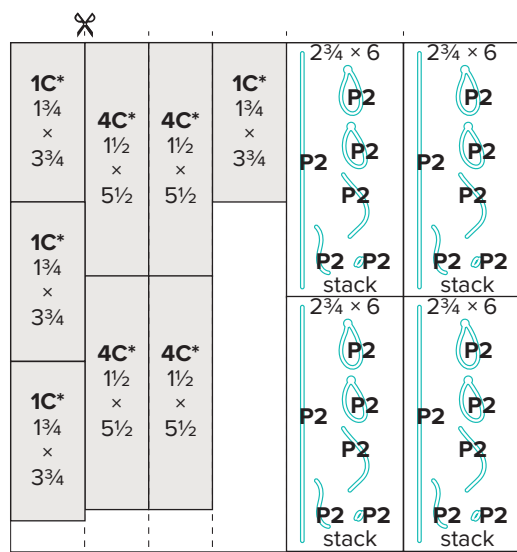

Honey Butter cardstock



dark

*light

Tip: See the Getting Started section on page two for additional information on how to make two die-cuts at once.

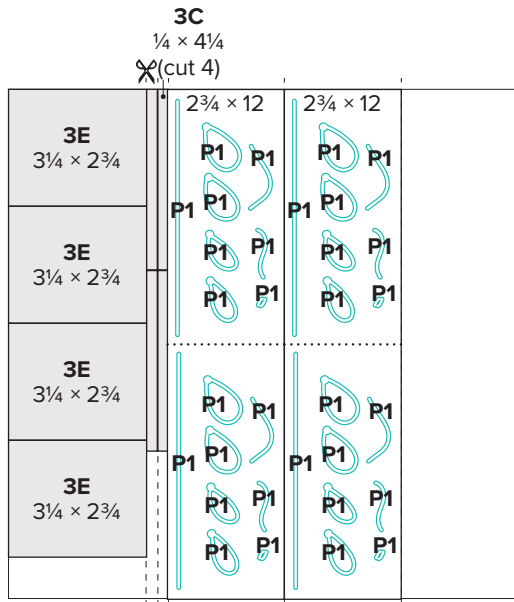

Black cardstock



Tip: See the Getting Started section on page two for additional information on how to make two die-cuts at once.

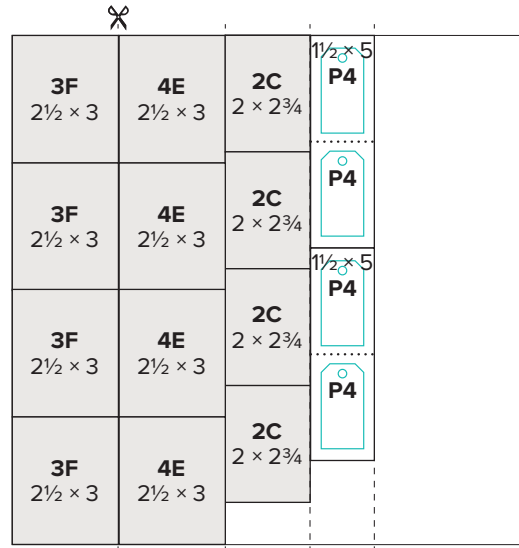

French Vanilla cardstock



Tip: See the Getting Started section on page two for additional information on how to make two die-cuts at once.

Project 1: Make 4

Prepare (4 each):



1B:
Paper: light Toffee
Ink: Toffee



1C:
Paper: light Honey Butter
Ink: Honey Butter

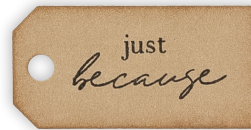

P1 Accent:
Paper: light Toffee
Inks: Black, Toffee
Tip: Cut a wedge out of the round sponge and use it to apply Toffee ink along the edges.
Technique: Gently rub the sponge on the ink pad and then lightly rub it along the edges of the cardstock until the desired amount of color is achieved.



Assemble:

1. Prepare pieces shown above
2. Attach 1A, prepared 1B, prepared 1C, and 1D
3. Attach P1 black cardstock string accent, as shown
4. Attach prepared Toffee tag accent, as shown
5. Assemble and attach P1 black cardstock bow accent, as shown
6. Embellish with flower die-cut

Project 2: Make 4

Prepare (4 each):



2A:
Paper: Toffee
Inks: Black, Toffee



2C:
Paper: French Vanilla
Inks: Black, Honey Butter, Toffee
Tip: Cut a wedge out of the round sponge and use it to apply Toffee ink along the edges.
Technique: Gently rub the sponge on the ink pad and then lightly rub it along the edges of the cardstock until the desired amount of color is achieved.

FOLD

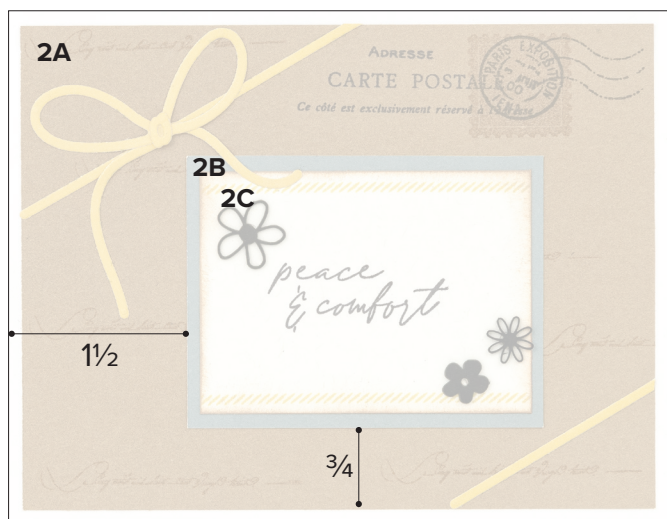

Assemble:

1. Prepare pieces shown above
2. Attach prepared 2A
3. Attach 2B
4. Attach prepared 2C
5. Attach P2 Honey Butter cardstock string accent, as shown
Tip: Trim as needed.
6. Assemble and attach P2 Honey Butter cardstock bow accent, as shown
7. Embellish with flower die-cuts

Project 3: Make 4



Prepare (4 each):

3B:

Paper: light Mist
 Inks: Black, Mist
 Tip: Use the second-generation stamping technique for the Mist circles.
 Technique: Ink the stamp in Mist and stamp it on a scratch piece of paper. Then, without re-inking, stamp on 3B.



3F:

Paper: French Vanilla
 Ink: Toffee
 Tips: Use the second-generation stamping technique for the square postage stamp.
 Technique: Gently rub the sponge on the ink pad and then lightly rub it along the edges of the cardstock until the desired amount of color is achieved.



P3 Accent:

Paper: light Mist
 Ink: Black

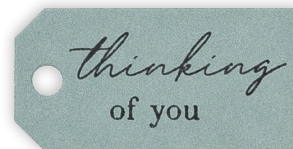

Assemble:

1. Prepare pieces shown above
2. Attach 3A, prepared 3B, 3C, and 3D
3. Attach 3E
4. Attach P3 Mist cardstock string accent to 3F, as shown
Tip: Cut the cardstock as needed to fit as shown.
5. Assemble and attach P3 Mist cardstock bow accent and prepared tag, as shown
6. Attach prepared 3F
7. Embellish with flower die-cuts

Project 4: Make 4

Prepare (4 each):



4E:

Paper: French Vanilla

Ink: Toffee

Tips: Use the second-generation stamping technique for the square postage stamp. Cut a wedge out of the round sponge and use it to apply the ink along the edges of the cardstock.

Techniques: Ink the stamp in Toffee and stamp it on a scratch piece of paper. Then, without re-inking, stamp on 4E.

Gently rub the sponge on the ink pad and then lightly rub it along the edges of the cardstock until the desired amount of color is achieved.

P4 Accent:

Paper: French Vanilla

Inks: Black, Mist, Toffee

Tips: Stamp the Mist background first and then stamp "hello" on top. Use the wedge from above to sponge the edges of the cardstock with Toffee ink.

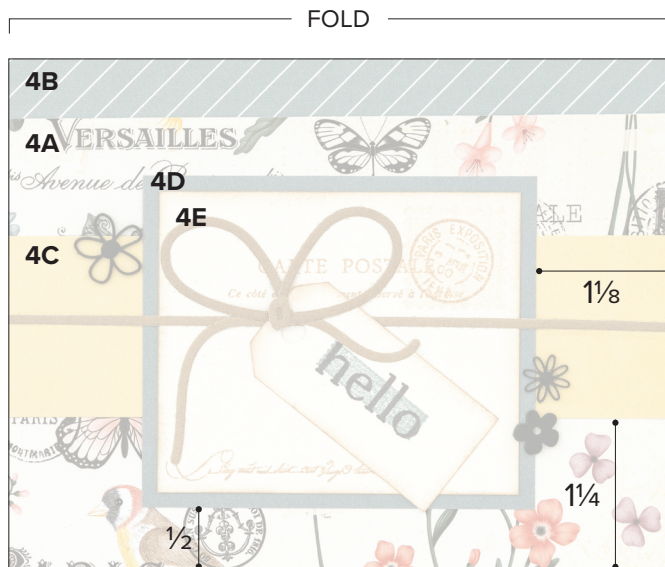

Assemble:

1. Prepare pieces shown above
2. Attach 4A
3. Attach 4B on top of 4A
4. Attach 4C
5. Attach 4D
6. Attach prepared 4E
7. Assemble and attach P4 Toffee cardstock bow accent and prepared tag, as shown
8. Embellish with flower die-cuts