

# HONEY BUNNY | 3 layouts

Featured Techniques: Paper Weaving and Tearing

## Project 1



## Project 2



## Project 3



### Materials Needed:

- G1299 Honey Bunny Scrapbooking Workshop Kit
- Z4575 Black LePen™
- Z1151 3-D Foam Tape
- Paper Trimmer

- Scissors
- Adhesive
- Ruler

**Gather photos (15 total)**

(P) = portrait (L) = landscape

|                  | 3 × 4 (P) | 4 × 4 | 4 × 6 (P) | 4 × 6 (L) |
|------------------|-----------|-------|-----------|-----------|
| <b>Project 1</b> | 3         | -     | -         | 1         |
| <b>Project 2</b> | -         | 4     | -         | 2         |
| <b>Project 3</b> | 3         | 1     | 1         | -         |

**Getting Started:**

- Gather all materials needed.
- Trim all zip strips and set aside. The zip strip is the 1/2" accent paper along the top of each sheet of patterned paper.
- Check the cut orientation below each cutting guide image. This will show you how to cut the paper, keeping the patterns on your project pieces facing the right direction.
- Light grey pieces on your cutting guide are project pieces. White pieces are leftover paper.
- As you cut the paper, label and sort the pieces as indicated in the cutting guide, creating a stack for each project.

**Key:**

✂ = first cut | \* = use back of paper

**Cutting Diagrams:**

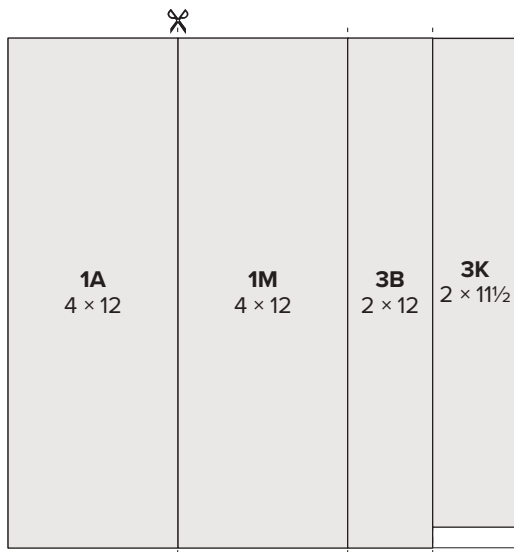

cut orientation



front

\*back

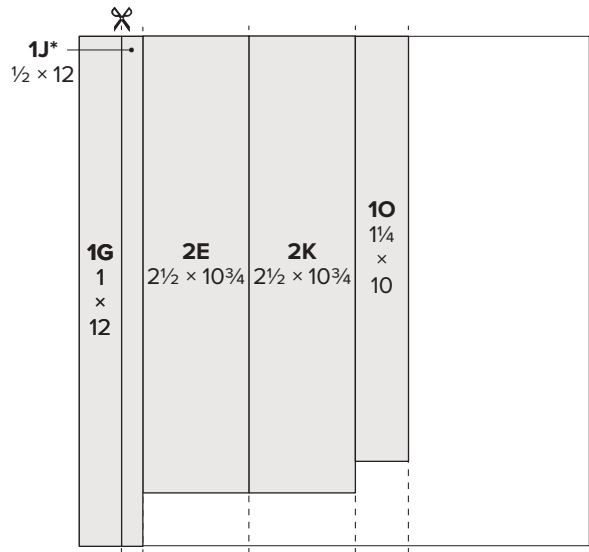

cut orientation



front

\*back

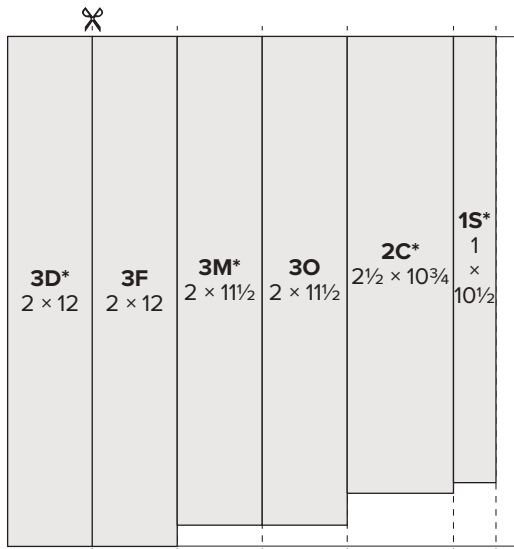

cut orientation



front



\*back

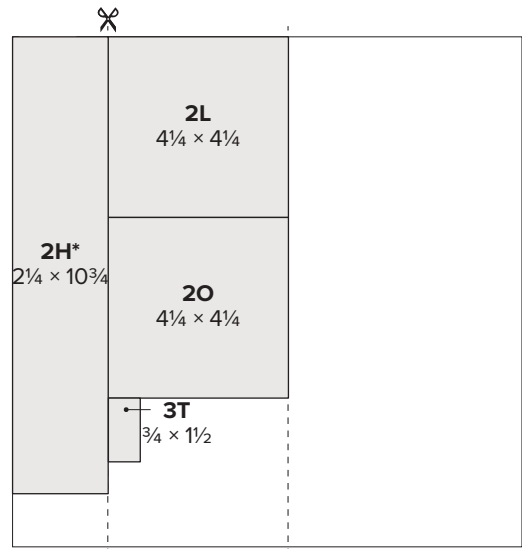

cut orientation

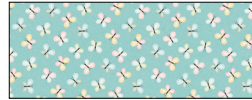

front



\*back

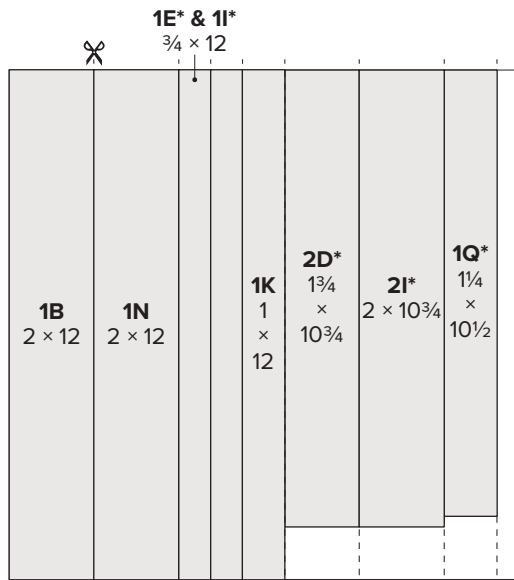

cut orientation

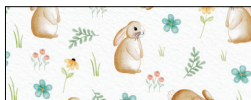

front

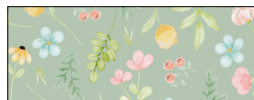

\*back

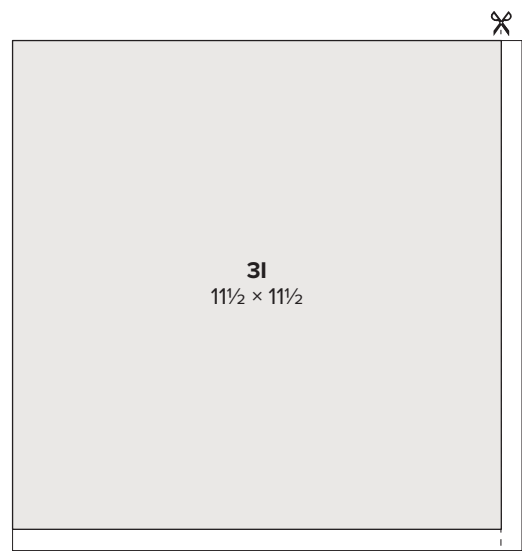

exclusive paper



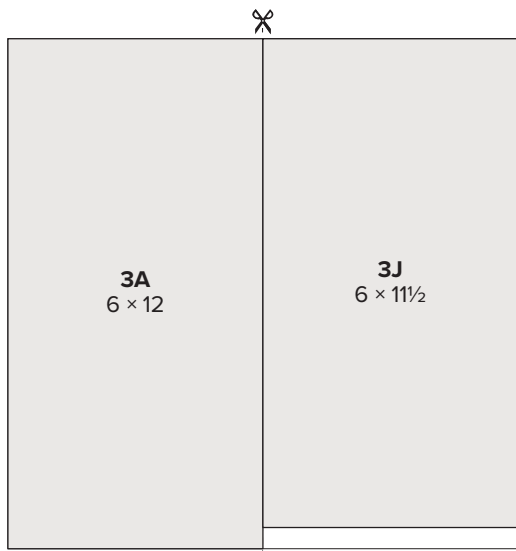

Honeybutter cardstock



light

\*dark

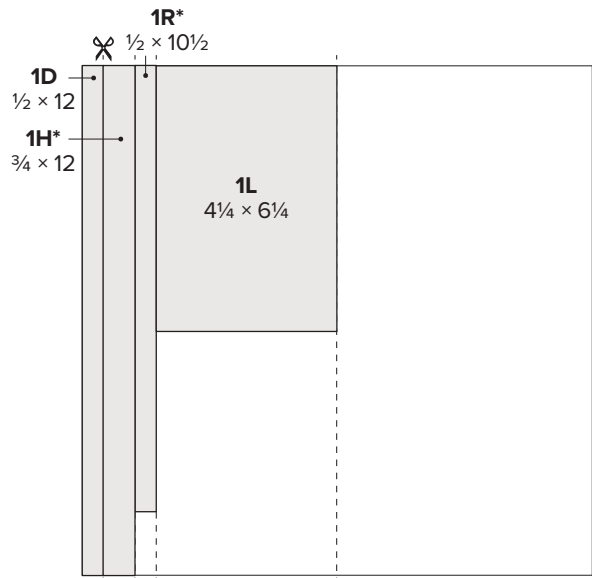

Honeybutter cardstock



light

\*dark

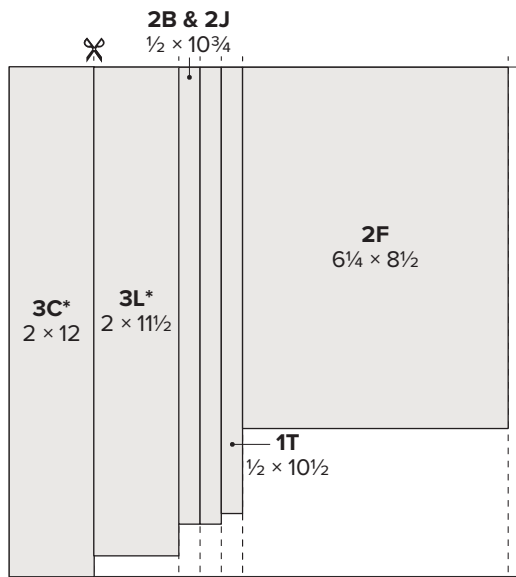

Glacier cardstock



dark

\*light

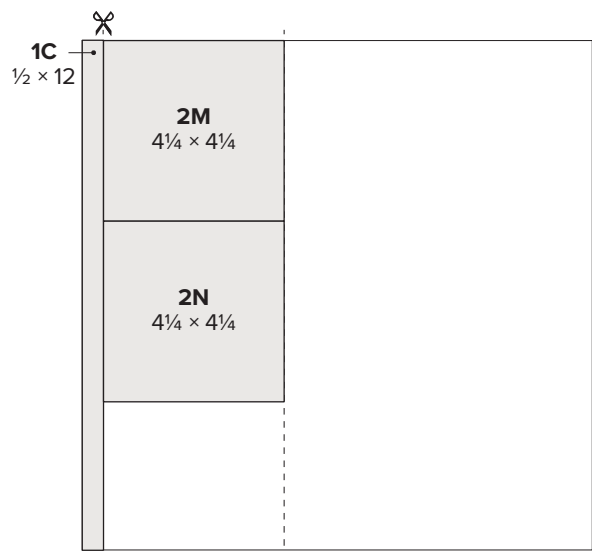

Glacier cardstock



dark

\*light



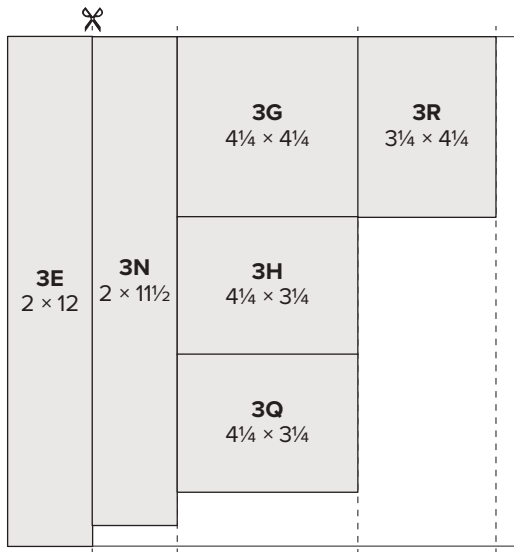

Peach cardstock

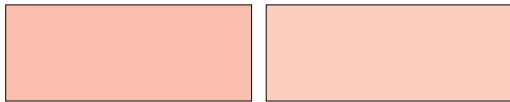

dark

\*light

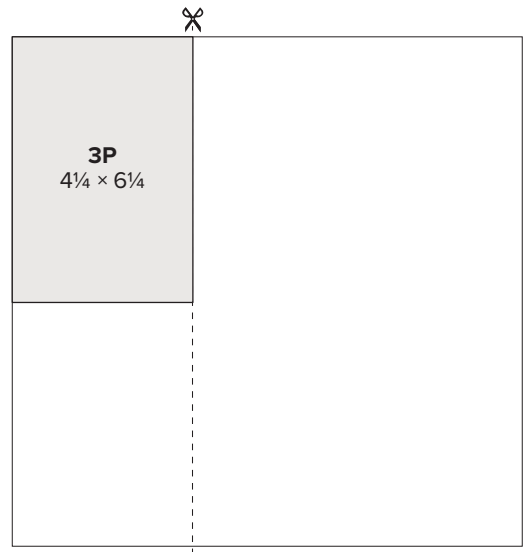

Peach cardstock

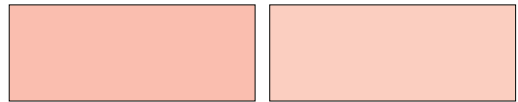

dark

\*light

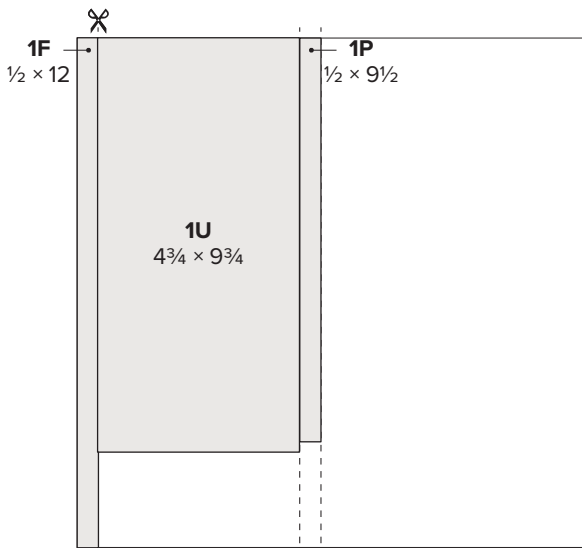

Sage cardstock



dark

\*light

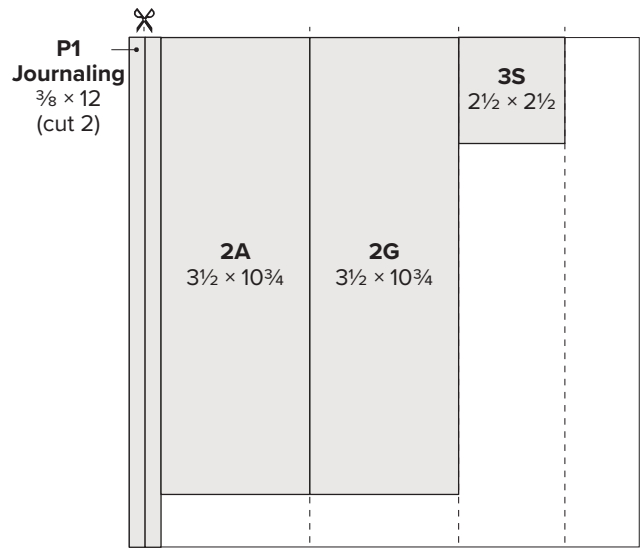

White Daisy cardstock



**Project 1: Left Page**

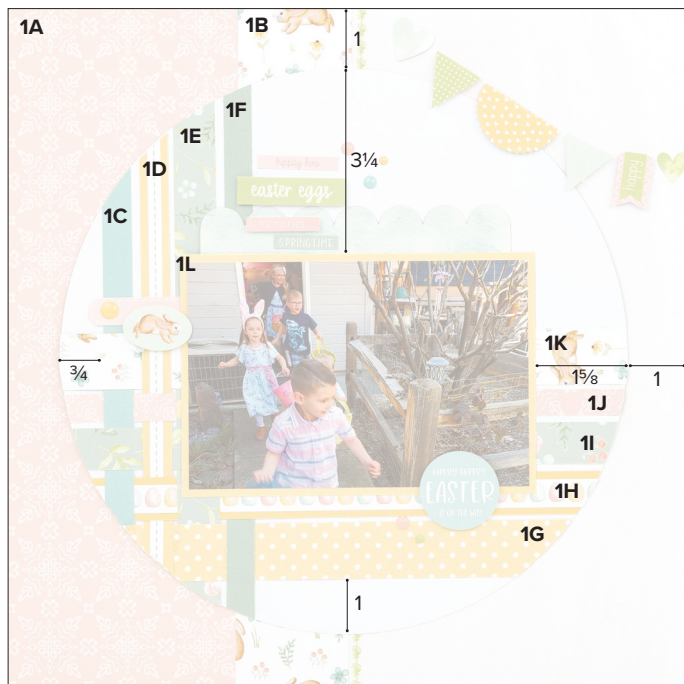

**Assemble:**

1. Use exclusive Peach patterned paper for base page
2. Attach 1A and 1B
3. Attach one leaf border sticker, as shown
4. Attach a stitched border sticker to 1D, as shown
5. Attach 1C, prepared 1D, 1E, and 1F to large white circle die-cut, as shown

*Tips: These paper strips are long enough so that the tops and bottoms will hang off the circle, and the excess will be trimmed in a later step. For now, only use adhesive along the parts of the strips that will attach along the top of the circle's edge, so that other pieces can be tucked behind them in a later step.*

6. Attach an egg border sticker to 1H, as shown
7. Attach 1G, prepared 1H, 1I, 1J, and 1K to large white circle die-cut, as shown

*Tips: These paper strips are long enough so that the right and left ends will hang off the circle, and the excess will be trimmed in a later step. Before attaching the paper strips to the die-cut, weave these strips into the attached vertical paper strips. Once they are all weaved through, adjust 1G–1K as needed and then attach them to the die-cut.*

*Technique: Interlace the horizontal paper strips into the vertical paper strips, over one and under one, repeating until done. Alternate the “over-under” pattern between paper strips.*

8. Attach any remaining unattached ends of paper strips to large circle die-cut and trim excess hanging off the edge
9. Attach 1L to prepared large circle die-cut  
*Tip: Do not use adhesive along the top or top left edge so other pieces can be tucked behind it in a later step.*
10. Attach photo
11. Attach prepared large circle die-cut to base page
12. Embellish with additional die-cuts, stickers, and dots  
*Tips: Attach a few embellishments with 3-D foam tape for added dimension. Tuck some embellishments slightly behind 1L.*

## Project 1: Right Page



### Assemble:

1. Use exclusive Peach patterned paper for base page
2. Attach 1M and 1N
3. Attach remaining leaf border sticker, as shown
4. Dovetail and attach 1O, 1P, and 1Q, as shown  
*Tip: Only use adhesive along the very right edge of each of these paper strips, approx. 1/4", so that other pieces can be tucked behind them in a later step.*
5. Attach stitched border sticker to 1R and trim excess
6. Dovetail and attach prepared 1R, 1S, and 1T, as shown  
*Tips: Before attaching these paper strips to the page, weave them into the attached horizontal strips. Once they are all weaved through, adjust 1R–1T as needed and then attach them to the base page.*  
*Technique: Interlace the vertical paper strips into the horizontal paper strips, over one and under one, repeating until done. Alternate the “over-under” pattern between paper strips.*
7. Attach any remaining unattached ends of paper strips to base page
8. Attach 1U  
*Tip: Do not use adhesive along the top right so other pieces can be tucked behind it in a later step.*
9. Attach photos, as shown
10. Embellish with die-cuts, stickers, and dots  
*Tips: Attach a few of these embellishments with 3-D foam tape for added dimension. Tuck some stickers slightly behind 1U.*
11. Add journaling



## Project 2: Left Page



### Assemble:

1. Use Sage cardstock for base page
2. Attach 2A, 2B, 2C, 2D, and 2E
3. Attach 2F
4. Attach photos
5. Draw stitch line border along three sides of 2A with Black LePen™, as shown
6. Embellish with die-cuts, stickers, and dots  
*Tip: Attach a few of these embellishments with 3-D foam tape for added dimension.*
7. Add journaling

## Project 2: Right Page



### Assemble:

1. Use Sage cardstock for base page
2. Attach 2G, 2H, 2I, 2J, and 2K
3. Attach 2L, 2M, 2N, and 2O
4. Attach photos
5. Draw stitch line border along three sides of 2G with Black LePen™, as shown
6. Embellish with die-cuts, stickers, and dots  
*Tip: Attach a few of these embellishments with 3-D foam tape for added dimension.*
7. Add journaling



**Project 3: Left Page**

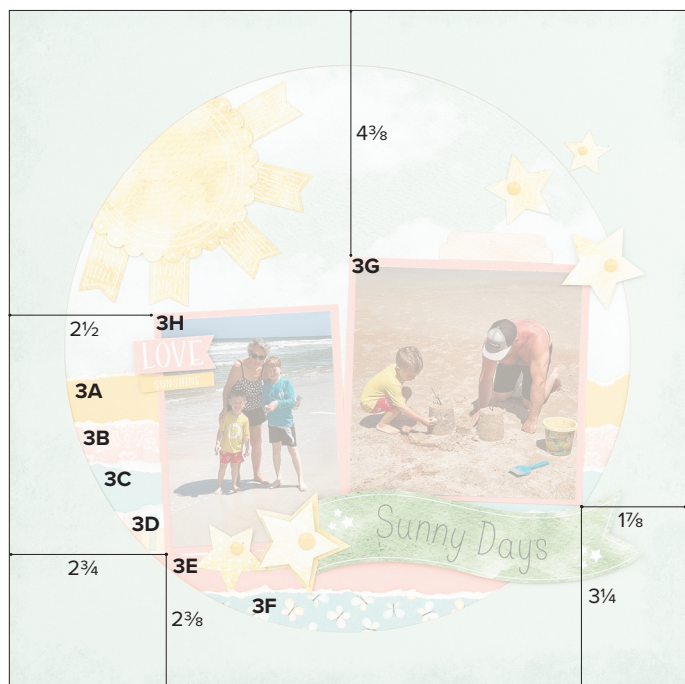

**Assemble:**

1. Use exclusive cloud patterned paper for base page
2. Tear approx. 1/2" from one long edge of 3A–3F
3. Attach 3A–3F to base page, as shown  
*Tips: Begin by attaching 3A, first. The bottom of 3A lines up with the bottom of the base page. Layer and attach the remaining pieces, in alphabetical order and approx. 1" from the previously attached layer's ripped edge, ending with 3F.*
4. Attach large frame die-cut, as shown  
*Tip: Do not use adhesive around the circle's edge so another piece can be tucked behind it in a later step.*
5. Attach photos to 3G and 3H
6. Attach 3G and 3H
7. Embellish with additional die-cuts, stickers, and dots  
*Tips: Attach a few of these embellishments with 3-D foam tape for added dimension. Tuck sun (scalloped circle) die-cut slightly behind the large frame die-cut.*

### Project 3: Right Page

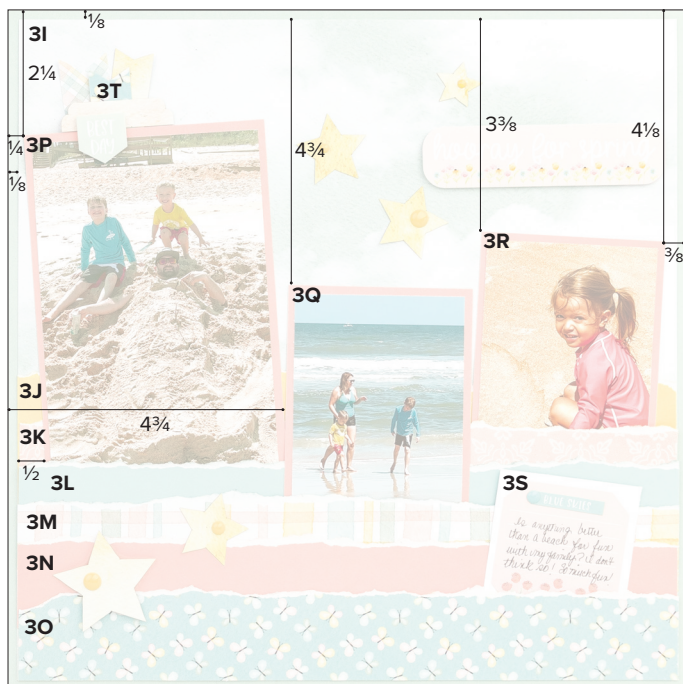

#### Assemble:

1. Use Seabrook cardstock for base page
2. Attach 3I
3. Tear approx.  $\frac{1}{2}$ " from one long edge of 3J–3O
4. Attach 3J–3O to base page, as shown  
*Tips: Begin by attaching 3J, first. The bottom of 3J lines up with the bottom of 3I. Layer and attach the remaining pieces, in alphabetical order and approx. 1" from the previously attached layer's ripped edge, ending with 3O in the front. Do not use adhesive along the top edges of 3K, 3L, 3M, or 3O so other pieces can be tucked behind them in a later step.*
5. Attach photos to 3P, 3Q, and 3R
6. Attach Peach journaling sticker to 3S
7. Attach 3P, 3Q, 3R, and 3S, as shown  
*Tips: Tuck these slightly behind 3K, 3L, 3M, and 3O. Do not use adhesive along the top of 3P so other pieces can be tucked behind it in a later step.*
8. Dovetail and attach 3T, along with dovetail die-cut and plaid dovetail sticker, as shown  
*Tip: Tuck these slightly behind 3P.*
9. Embellish with additional die-cuts, additional stickers, and dots  
*Tip: Attach a few of these embellishments with 3-D foam tape for added dimension.*
10. Add journaling