

Some Kinda Wonderful

1. Gather photos (14 total); where applicable, photo orientation is noted as either portrait (P) or landscape (L)

Project 1	Project 2	Project 3
2 - 4 × 6 (L)	1 - 5 × 7 (P)	2 - 4 × 6 (P)
2 - 4 × 6 (P)	2 - 4 × 6 (L)	1 - 3 × 4 (P)
1 - 3 × 4 (P)	2 - 3 × 3	
1 - 3 × 3		

2. Trim and save all zip strips from B&T Duos™

3. Cut apart pocket cards

4. Cut paper according to diagrams; sort the pieces by project number, creating a stack for each of the layouts and the cards (projects are numbered 1-6)

CUTTING DIAGRAMS (1 of 3) (all dimensions are in inches; first cuts indicated by scissors)

layout cuts card cuts

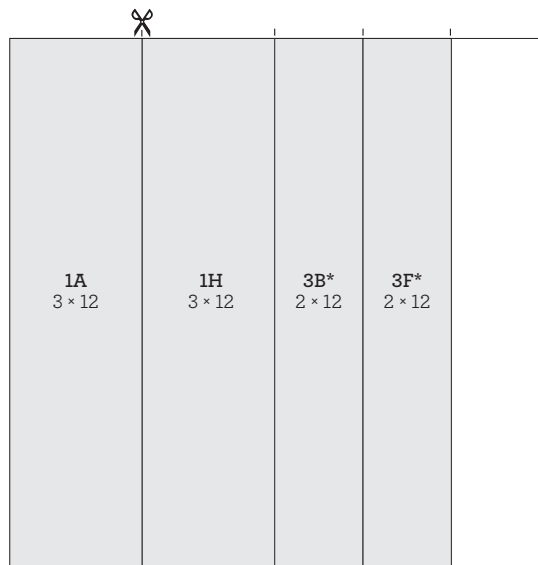

Front

*Back of paper

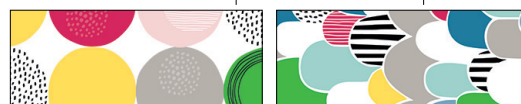
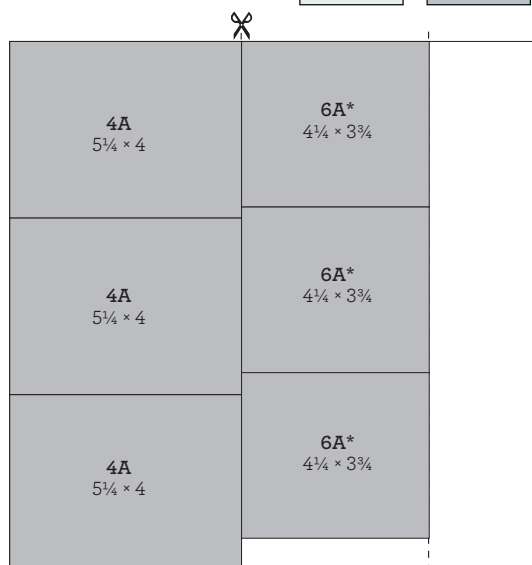

Front

*Back of paper

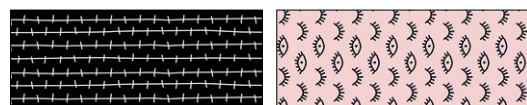
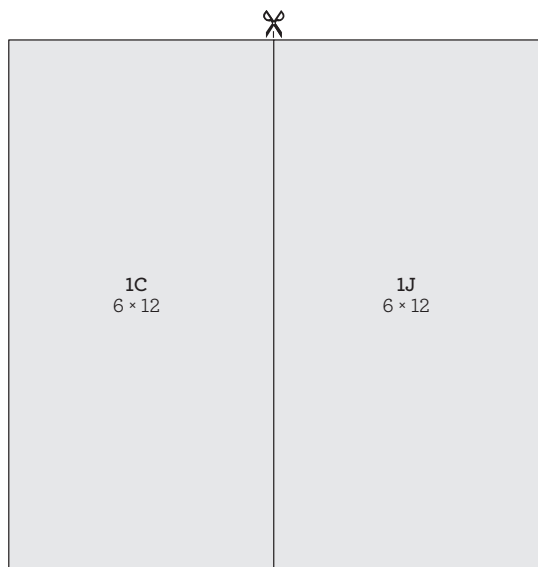

Front

Back

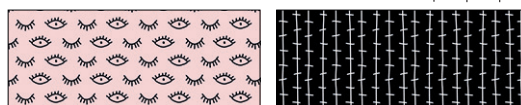
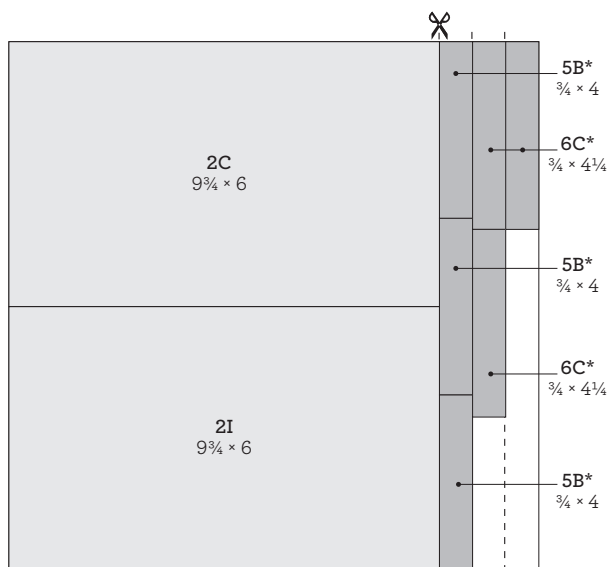

Front

*Back of paper

CUTTING DIAGRAMS (2 of 3)

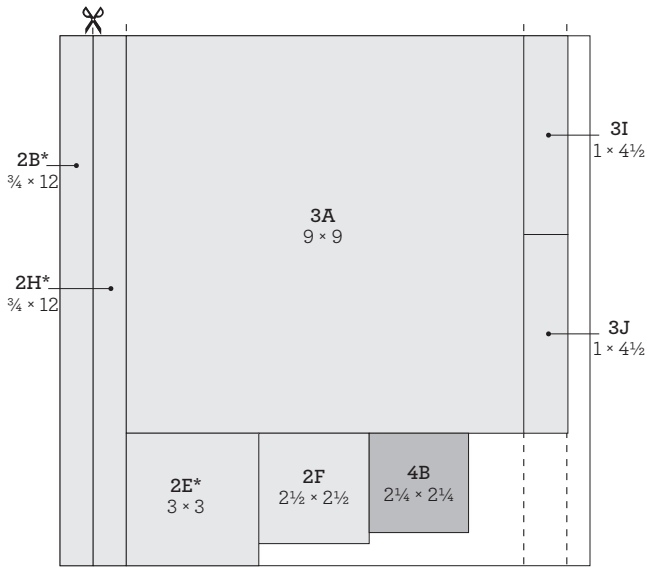

Front

*Back of paper

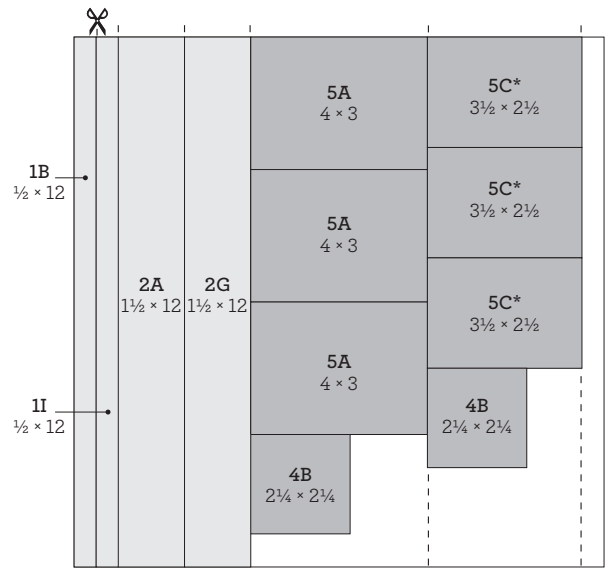

Front

*Back of paper

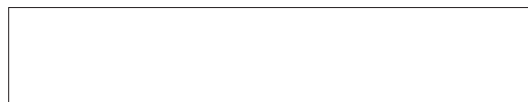
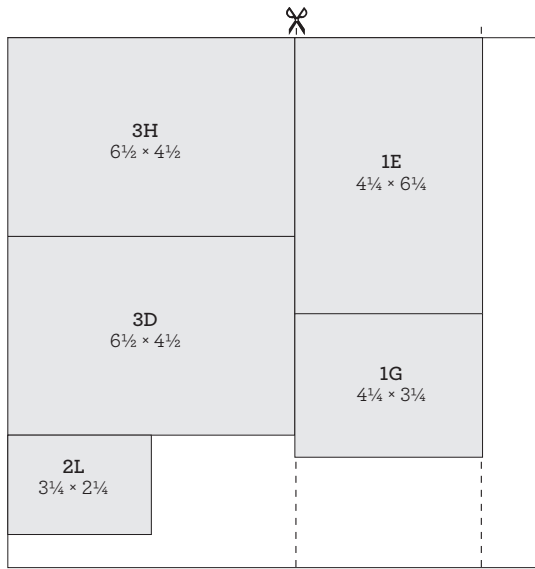

White Daisy cardstock

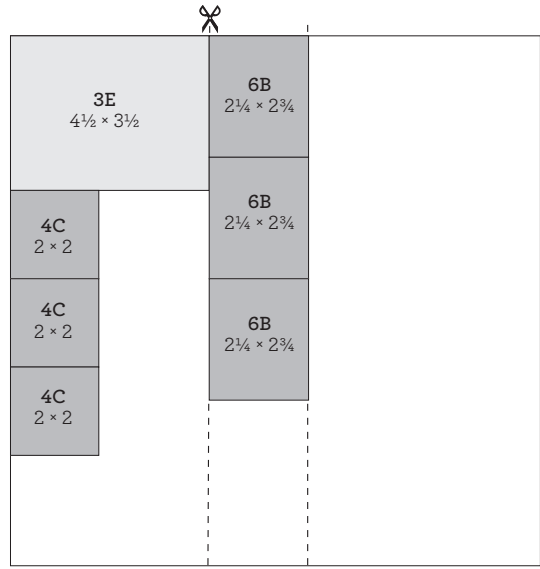

White Daisy cardstock

CUTTING DIAGRAMS (3 of 3)

Trim and set aside the following pocket cards and zip strips:

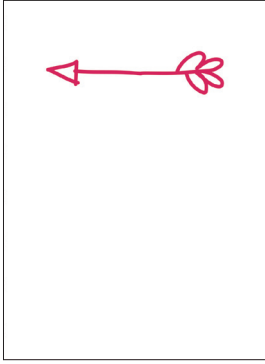

1L: 3 × 4 pocket card

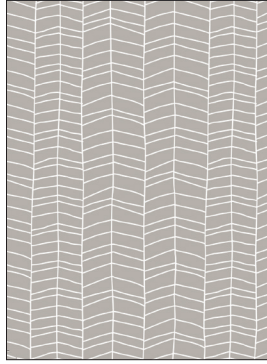

2K: 3 × 4 pocket card

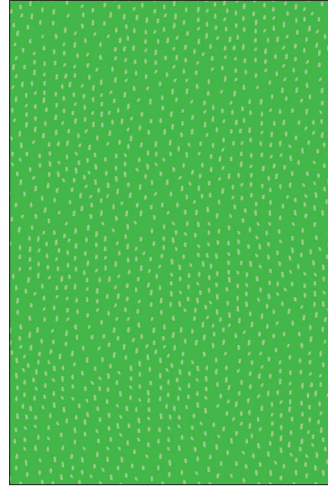

1F: 4 × 6 pocket card



3K: 3 × 4 pocket card



1D: ½ × 12 zip strip



1K: ½ × 12 zip strip



2D: ½ × 9¾ zip strip



2J: ½ × 9¾ zip strip



3C: ½ × 12 zip strip



3G: ½ × 12 zip strip

Project 1: 12 × 12 Layout

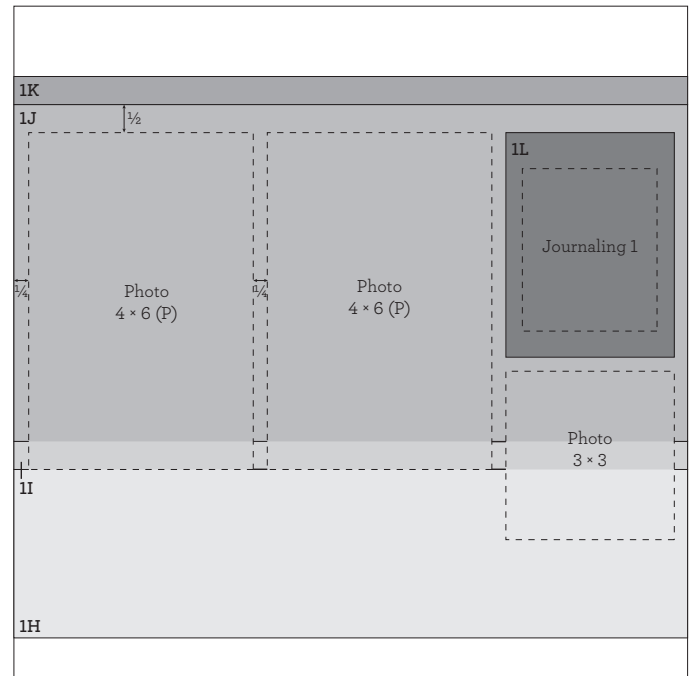
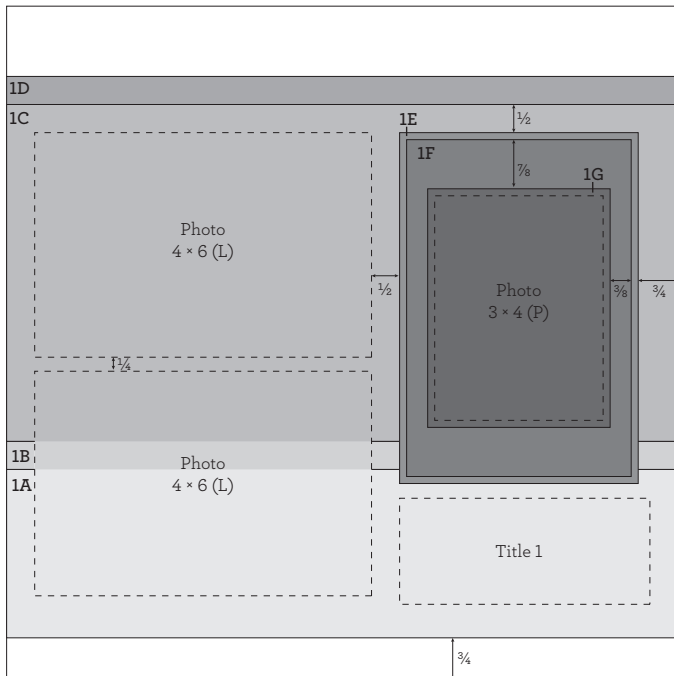

TIPS

- Use White Daisy cardstock for base pages
- Use zip strips for 1D and 1K
- Use 4 × 6 pocket card for 1F
- Attach “#Today” from Some Kinda Wonderful Complements to 1A for Title 1

- Use 3 × 4 pocket card for 1L and add journaling for Journaling 1 if desired
- Embellish layout with twine, Some Kinda Wonderful Complements, and enamel dots as desired

Project 2: 12 × 12 Layout

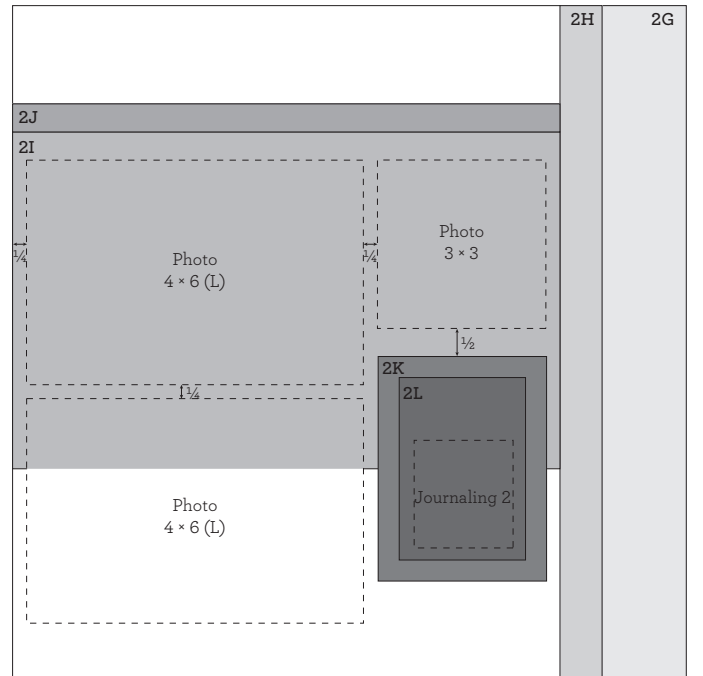
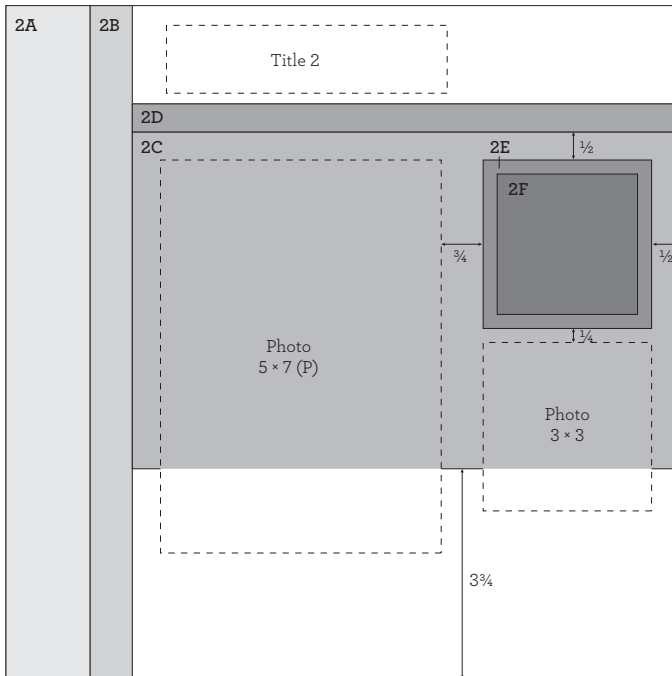

TIPS

- Use Black dash B&T Duos™ paper for base pages
- Use zip strips for 2D and 2J
- Attach “Best Friends” from Some Kinda Wonderful Complements for Title 2

- Use 3 × 4 pocket card for 2K
- Add journaling to 2L for Journaling 2 if desired
- Embellish layout with twine, Some Kinda Wonderful Complements, and enamel dots as desired

Project 3: 12 × 12 Layout

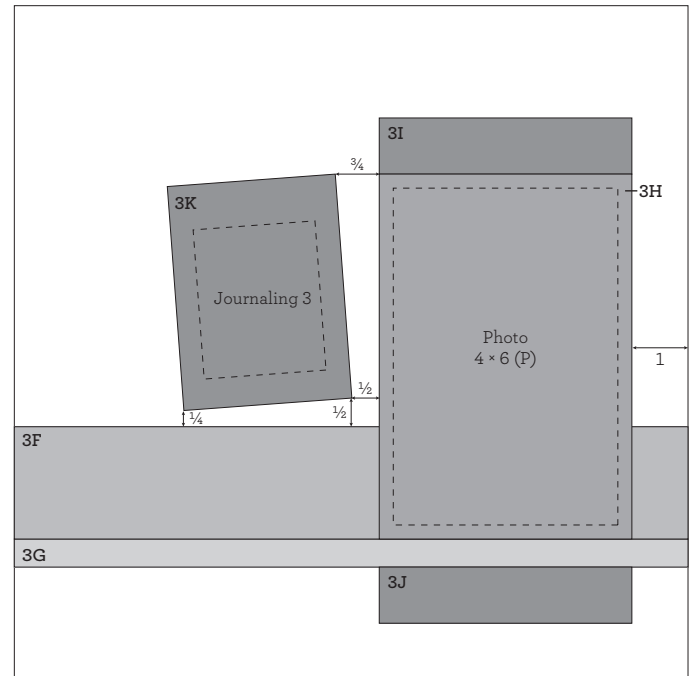
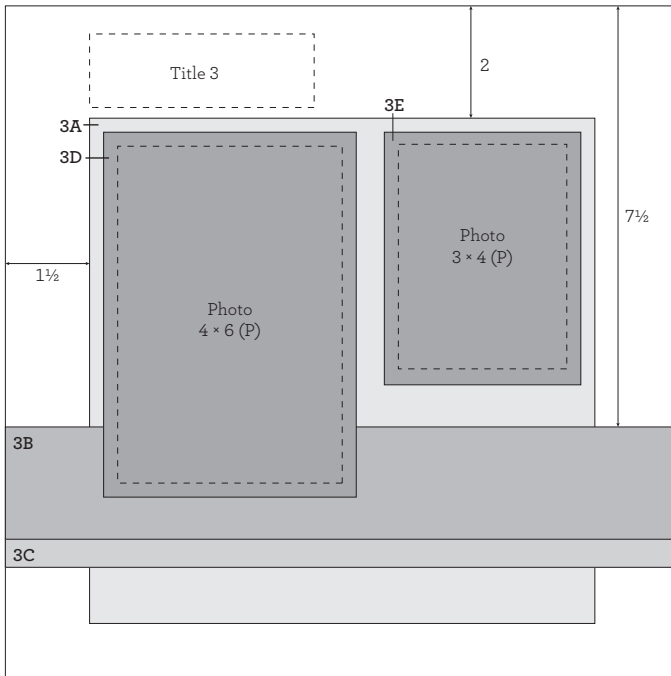

TIPS

- Use Whisper caret B&T Duos™ paper for base pages
- Use zip strips for 3C and 3G
- Attach “#Life” from Some Kinda Wonderful Complements to left base page for Title 3
- Use 3 × 4 pocket card for 3K and add journaling for Journaling 3 if desired

- Embellish layout with twine, Some Kinda Wonderful Complements, and enamel dots as desired
- Add extra photos and pocket cards to this layout pattern designed especially for Pocket Plus™ Memory Protectors™; turn the page to see inspiration

Optional Pocket Plus™ Add-on

Use any 6" wide Pocket Plus™ Memory Protectors™ to add extra photos and pocket cards to Project 3 and arrange as desired.

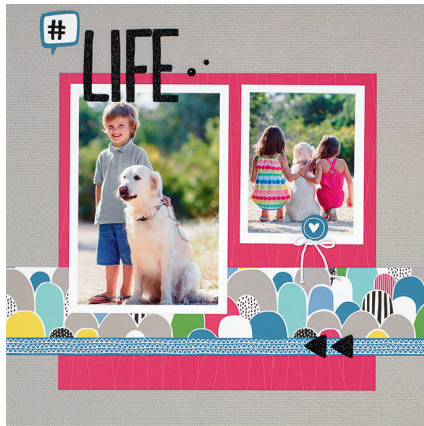

— Pocket Plus™ front —



— Pocket Plus™ inside —



— Pocket Plus™ back —



Optional Cardmaking Project

3 card designs (3 of each, 9 total)

ADDITIONAL MATERIALS NEEDED

- Z3302 Some Kinda Wonderful Cardmaking Thin Cuts Bundle
- Z3271 Archival Black Exclusive Inks™ Stamp Pad
- Z2812 Raspberry Exclusive Inks™ Stamp Pad
- Z1151 3-D Foam Tape
- X254 White Cards & Envelopes Value Pack

Project 4: Vertical $4\frac{1}{4} \times 5\frac{1}{2}$ Card (Make 3)

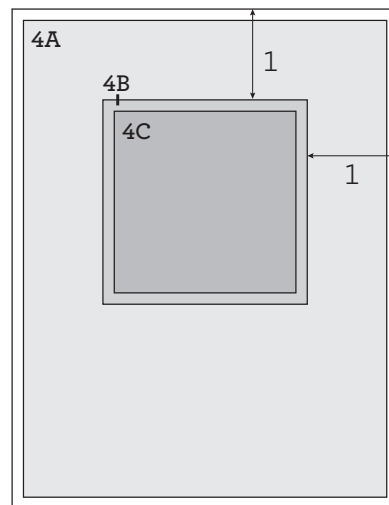

Tips:

- Using Archival Black ink, stamp “You did it!” sentiment onto 4C
- Attach 4C to 4B then wrap twine around both before attaching to 4A with 3-D foam tape if desired
- Using Some Kinda Wonderful Cardmaking Thin Cuts, cut turtle from scrap White Daisy cardstock; stamp corresponding image using Archival Black ink
- Color in turtle image using watercolors, then attach to 4C using 3-D foam tape if desired
- Embellish card with enamel dots as desired

Project 5: Vertical 4¼ × 5½ Card (Make 3)

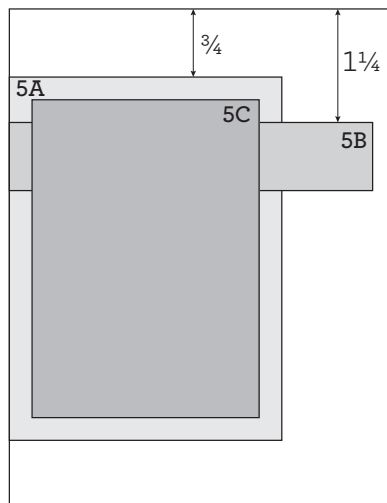

Tips:

- Dovetail right end of 5B, then wrap twine around it before attaching to 5A
- Using Some Kinda Wonderful Cardmaking Thin Cuts, cut fox and quote bubble from scrap White Daisy cardstock; stamp corresponding images using Archival Black ink
- Color in fox using watercolors, then attach to 5C using 3-D foam tape if desired

- Using Raspberry ink, stamp “Hello” sentiment onto quote bubble
- Using Archival Black ink, stamp “I’ve been thinking of you” sentiment to right of 5A
- Using Raspberry ink, stamp heart under sentiment
- Embellish card with enamel dots as desired

Project 6: Horizontal 4¼ × 5½ Card (Make 3)

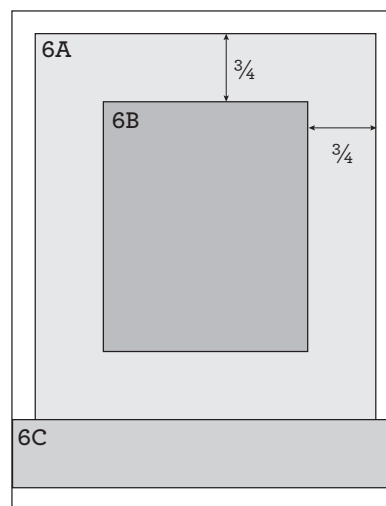

Tips:

- Wrap twine around 6C then attach to card base using 3-D foam tape if desired
- Using Some Kinda Wonderful Cardmaking Thin Cuts, cut bird from scrap White Daisy cardstock; stamp corresponding image using Archival Black ink
- Color in bird using watercolors, then attach using thin 3-D foam tape if desired

- Using Some Kinda Wonderful Cardmaking Thin Cuts, cut quote bubble from scrap Raspberry B&T Duos™ paper; stamp corresponding image and “HB2U” sentiment using Archival Black ink
- Embellish card with enamel dots as desired